

TRABAJO: ANÁLISIS DE EFICIENCIA ENERGÉTICA DE LA GRANJA IRQUIS DE LA UNIVERSIDAD DE CUENCA
 LUGAR: CUENCA
 UBICACIÓN: PARROQUIA VICTORIA DEL PORTETE (TARQUI)
 DESCRIPCIÓN: DIAGRAMAS DE: ILUMINACIÓN, TOMACORRIENTES, CARGAS ESP., SIMBOLOGÍA, NOMENCLATURA
 UBICACIÓN DE BLOQUES DE INFRAESTRUCTURA EN LA GRANJA IRQUIS: BLOQUE C (PLANTA DE LACTEOS)

ANEXO GRÁFICO N°







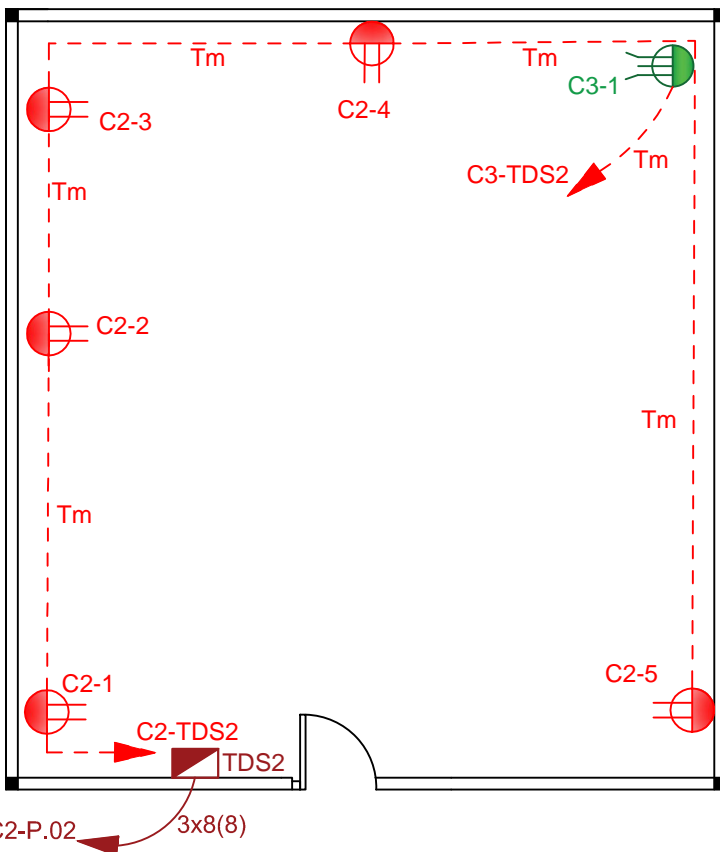
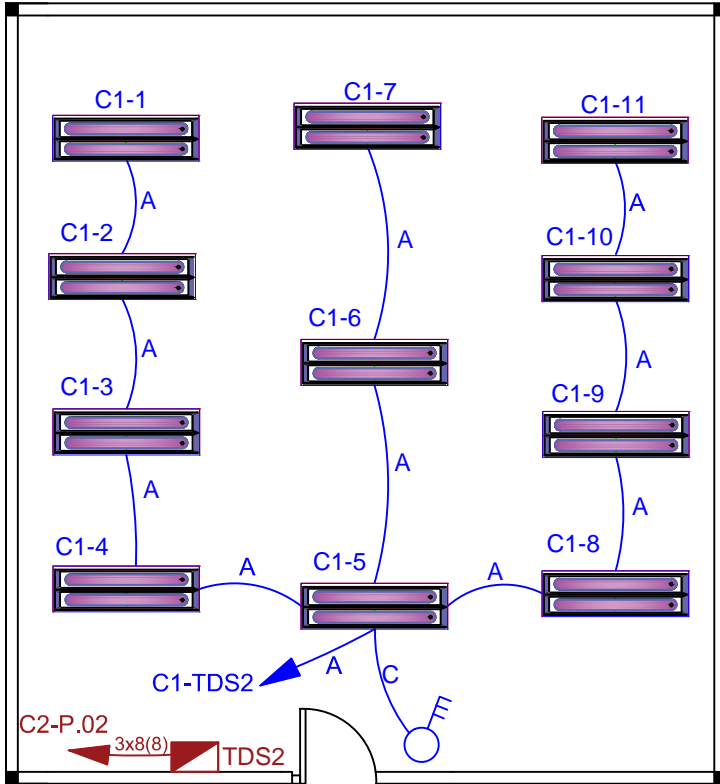















3

ANEXO 3.3

PLANTA DE LACTEOS



SIMBOLOGÍA ELÉCTRICA

	TDS	Tablero de Distribución Secundario 110V 1Ø
	TDS	Tablero de Distribución Secundario 220V 2Ø
	CP1	Caja de Paso para Distribución
		Tablero de Identificación de Cargas Especiales
		Conductor para Circuitos de Iluminación 120 V
		Conductor para Circuitos de Tomacorriente 120 V
		Interruptor Bticino Simple 120V
		Interruptor Bticino Doble 120V
		Interruptor Bticino Doble 120V
		Tomacorriente Polarizado Doble 120V
		Tomacorriente Polarizado Doble 220V Bifásico
		Luminaria Fluorescente (2x17 W)
		Luminaria Fluorescente (3x17 W)
		Luminaria Fluorescente (2x32 W)
		Luminaria Fluorescente (3x32 W)
		Luminaria Fluorescente (4x32 W)
		Luminaria Fluorescente (2x40 W)
		Foco Ahorrador de 13 W
		Foco Ahorrador de 20 W
		Foco Ahorrador de 23 W
		Foco Ahorrador de 27 W
		Foco Ahorrador de 40 W

NOMENCLATURA

A = Conductor AWG 2x12 THHN, en Tubería PVC de 1/2"
 B = Conductor AWG 3x12 THHN, en Tubería PVC de 1/2"
 C = Conductor AWG 4x12 THHN, en Tubería PVC de 1/2"
 D = Conductor AWG 5x12 THHN, en Tubería PVC de 3/4"
 E = Conductor AWG 6x12 THHN, en Tubería PVC de 3/4"
 F = Conductor AWG 3x6+1x8, en Tubería PVC de 1"
 G = Conductor AWG 3x8, en Tubería PVC de 1"